

# Grüne Laser Diode in TO38 ICut Bauform

## Green Laser Diode in TO38 ICut Package

PL 520 **PRELIMINARY**



### Besondere Merkmale

- Optische Ausgangsleistung (Dauerstrich-Betrieb): 50mW ( $T_{\text{Case}} = 25^{\circ}\text{C}$ )
- Typ. Emissionswellenlänge: 520nm
- Effiziente Strahlungsquelle für Dauerstrich- und gepulsten Betriebsmodus
- Transversal Monomode Halbleiterlaser
- Hohe Modulationsbandbreite
- Miniaturisiertes TO38 ICut Gehäuse
- Laserdiode isoliert gegen Gehäuse

### Anwendungen

- Laserprojektion
- Lasershows
- Bio- und Medizintechnik
- Holographie
- Messtechnik

### Sicherheitshinweise

Je nach Betriebsart emittieren diese Bauteile hochkonzentrierte, sichtbare Strahlung, die gefährlich für das menschliche Auge sein kann. Produkte, die diese Bauteile enthalten, müssen gemäß den Sicherheitsrichtlinien der IEC-Norm 60825-1 behandelt werden.

### Features

- Optical output power (continuous wave): 50mW ( $T_{\text{Case}} = 25^{\circ}\text{C}$ )
- Typ. emission wavelength: 520nm
- Efficient radiation source for cw and pulsed operation
- Single transverse mode semiconductor laser
- High modulation bandwidth
- Miniaturized TO38 ICut package
- Laser diode isolated against package

### Applications

- Laser projection
- Laser shows
- Biomedical Applications
- Holography
- Metrology

### Safety Advice

Depending on the mode of operation, these devices emit highly concentrated visible light which can be hazardous to the human eye. Products which incorporate these devices have to follow the safety precautions found in IEC 60825-1 "Safety of laser products".



**ATTENTION - Observe Precautions For Handling - Electrostatic Sensitive Device**

<b>Typ Type</b>	<b>Opt. Ausgangsleistung Optical Output Power <math>P_{op}</math> (mW) (<math>T_{Case} = 25^{\circ}\text{C}</math>)</b>	<b>Bestellnummer Ordering Code</b>
PL 520	50	Q65111A2445

**Grenzwerte**

Betrieb außerhalb dieser Bedingungen kann das Bauteil schädigen

**Maximum Ratings**

Operation outside these conditions may damage the device

<b>Bezeichnung Parameter</b>	<b>Symbol Symbol</b>	<b>Wert Values</b>		<b>Einheit Unit</b>
		<b>min.</b>	<b>max.</b>	
Betriebsstrom <sup>1)</sup> Operating Current <sup>1)</sup>	$I_F$	-	200	mA
Betriebstemperatur <sup>1)</sup> Operating Temperature <sup>1)</sup>	$T_{Case}$	+ 0	+ 60	°C
Lagertemperatur Storage Temperature	$T_{stg}$	- 40	+ 85	°C
Sperrspannung Reverse Voltage	$V_R$	-	2	V
Löttemperatur max. 10 sec. Soldering Temperature max. 10 sec.	$T_{solder}$	-	260	°C
Sperrschichttemperatur <sup>1)</sup> Junction temperature <sup>1)</sup>	$T_j$	-	150	°C

<sup>1)</sup> Der Betrieb bei den Grenzwerten beeinflusst die Lebensdauer.  
Operation at maximum ratings may influence the life time.

**Laserkennwerte** ( $T_{\text{case}} = 25\text{ °C}$ )

**Laser Characteristics** ( $T_{\text{case}} = 25\text{ °C}$ )

Bezeichnung Parameter	Symbol Symbol	Wert Values			Einheit Unit
		min.	typ.	max.	
Emissionswellenlänge <sup>1)</sup> Emission Wavelength <sup>1)</sup>	$\lambda_{\text{peak}}$	515	520	530	nm
Spektrale Breite (Halbwertsbreite) <sup>1)</sup> Spectral Width (FWHM) <sup>1)</sup>	$\Delta\lambda$	–	2	–	nm
Schwellstrom Threshold Current	$I_{\text{th}}$	–	45	75	mA
Betriebsstrom <sup>1)</sup> Operating Current <sup>1)</sup>	$I_{\text{F}}$	–	150	160	mA
Betriebsspannung <sup>1)</sup> Operating Voltage <sup>1)</sup>	$V_{\text{F}}$	–	7.0	8.0	V
Strahldivergenz (FWHM) <sup>1)</sup> Beam Divergence (FWHM) <sup>1)</sup>	$\theta_{\parallel} \times \theta_{\perp}$	4x16	7x22	11x25	deg
Polarisation <sup>1)</sup> Polarization <sup>1)</sup>	$P_{\text{gr}}$	20:1	–	–	
Modulationsfrequenz Modulation Frequency	$f$	–	>100	–	MHz
Thermischer Widerstand (pn-Übergang zu Gehäuse) Thermal resistance (junction to case)	$R_{\text{th}}$	–	38	–	K/W

<sup>1)</sup> Standardbetriebsbedingungen beziehen sich auf  $P_{\text{op}} = 50\text{mW}$  Ausgangsleistung im Dauerstrich-Betrieb.  
Standard operating conditions refer for to a continuous wave output power of  $P_{\text{op}} = 50\text{mW}$ .

**Typische Ausgangsleistung**  
**Optical Output Power**

$$P_{opt} = f(I_F)$$

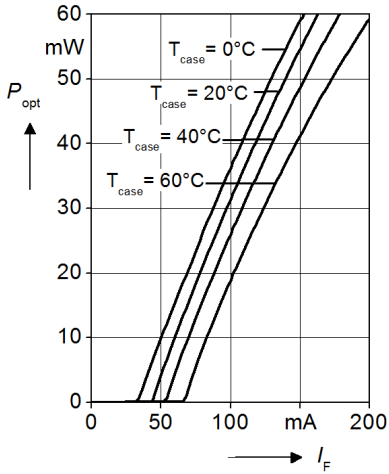

**Betriebsspannung**  
**Operating Voltage**

$$V_F = f(I_F)$$

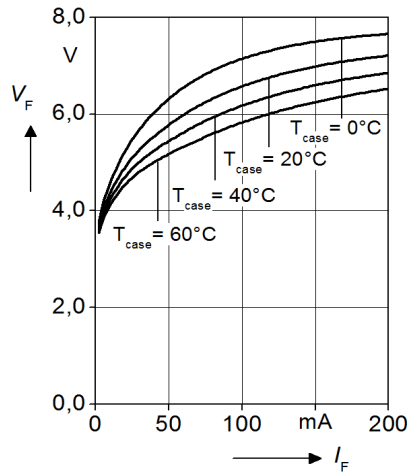

**Schwellstrom**  
**Threshold Current**

$$I_{th} = f(T_{Case})$$

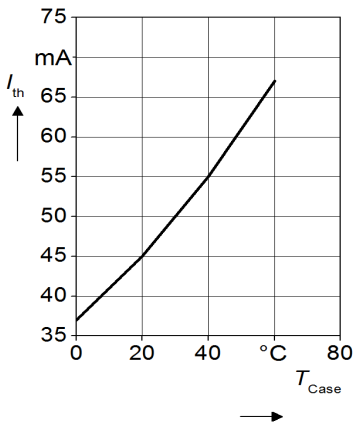

**Spektr**  
**Spectra**

$$\lambda = f(T_{Case})$$

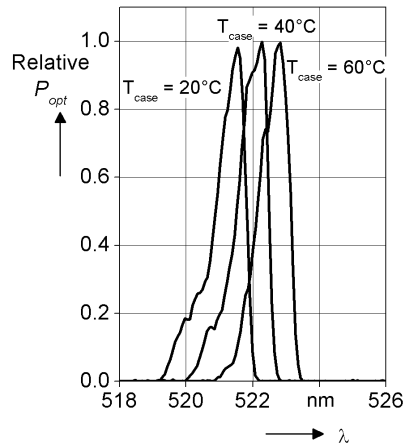

**Strahldivergenz**  
**Beam Divergence**

$P_{opt} = f(\theta), T_{Case} = 25^{\circ}\text{C}$

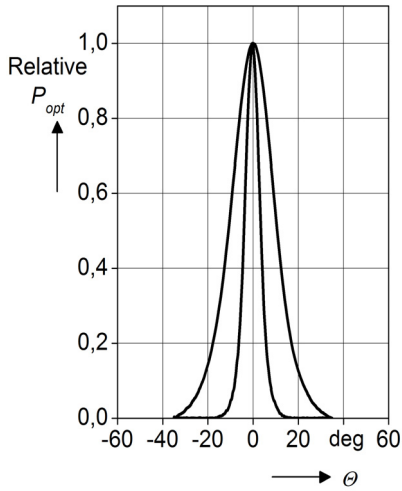

**Wichtige Hinweise zum Betrieb der Laserdiode:****a) Elektrischer Betrieb:**

OSRAMs Laserdioden sind mit dem Ziel höchster Leistung und Zuverlässigkeit gefertigt. Der Betrieb der Laserdiode oberhalb der im Datenblatt angegebenen Maximalwerte kann jedoch die Leistung und die Zuverlässigkeit erheblich beeinträchtigen. Daher sollte die Laserdiode auch mit einer möglichst rauscharmen Stromversorgung betrieben werden. Die Laserdiode ist sehr empfindlich gegenüber elektrostatischen Entladungen (ESD). Entsprechende Vorsichtsmaßnahmen sind zu treffen.

**b) Verarbeitungshinweise:**

Ein geeignetes Wärmemanagement ist ausschlaggebend für eine lange Lebensdauer der Laserdiode. Auf Grund des Designs wird die in der Diode erzeugte Wärme hauptsächlich über die Grundplatte des Gehäuses abgeführt. Es muss sichergestellt sein, dass eine ausreichend gut wärmeleitende Verbindung zwischen der Diodengrundplatte und dem Kühlkörper besteht.

**Important notes of operation for laser diode:****a) Electrical operation:**

OSRAMs laser diodes are designed for maximum performance and reliability. Operating the laser diode above the maximum rating even for very short periods of time can damage the laser diode or reduce its lifetime. The laser diode must be operated with a suitable power supply with minimized electrical noise. The laser diode is very sensitive to electrostatic discharge (ESD). Proper precautions must be taken.

**b) Mounting instructions:**

In order to maintain the lifetime of the laser diode proper heat management is essential. Due to the design of the laser diode heat is dissipated only through the base plate of the diode's body. A proper heat conducting interconnection between the diodes base plate and the heat sink must be maintained.

**Maßzeichnung  
Package Outlines**

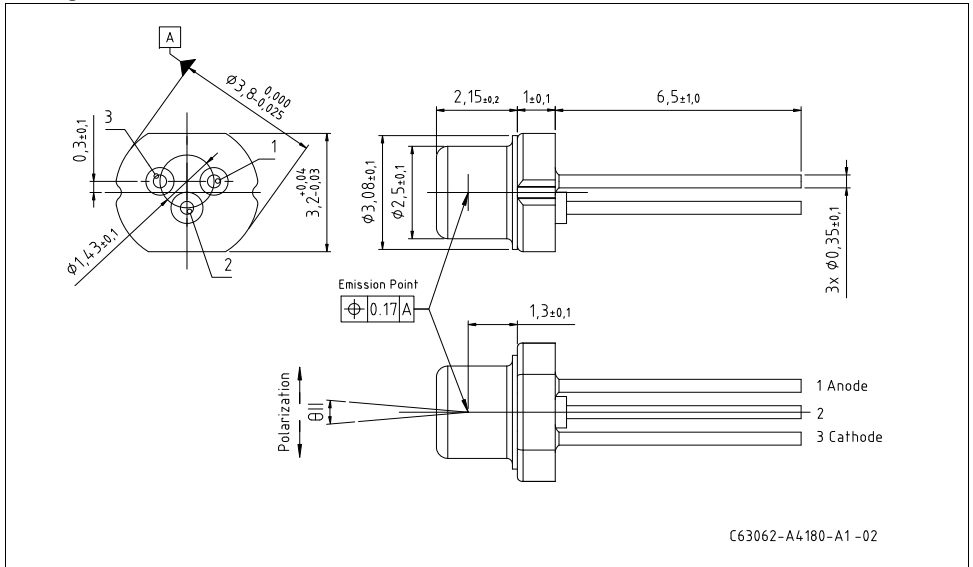

Maße in mm / Dimensions in mm

**Pinbelegung  
Pin Connection**

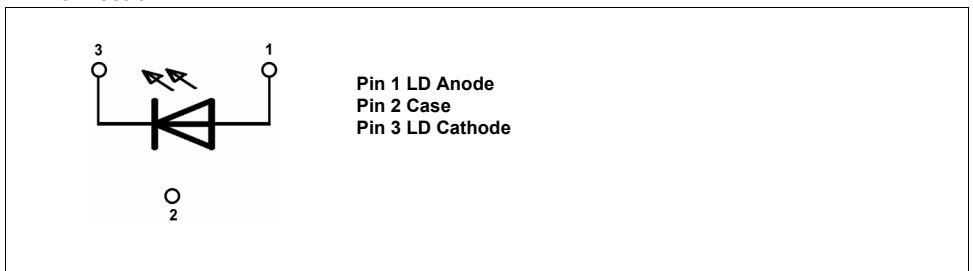

Published by  
OSRAM Opto Semiconductors GmbH  
Leibnizstrasse 4, D-93055 Regensburg  
[www.osram-os.com](http://www.osram-os.com)  
© All Rights Reserved.

The information describes the type of component and shall not be considered as assured characteristics. Terms of delivery and rights to change design reserved. Due to technical requirements components may contain dangerous substances. For information on the types in question please contact our Sales Organization.

**Packing**

Please use the recycling operators known to you. We can also help you get in touch with your nearest sales office. By agreement we will take packing material back, if it is sorted. You must bear the costs of transport. For packing material that is returned to us unsorted or which we are not obliged to accept, we shall have to invoice you for any costs incurred.

**Components used in life-support devices or systems must be expressly authorized for such purpose!** Critical components, may only be used in life-support devices or systems with the express written approval of OSRAM OS.

A critical component is a component used in a life-support device or system whose failure can reasonably be expected to cause the failure of that life-support device or system, or to affect its safety or effectiveness of that device or system. Life support devices or systems are intended (a) to be implanted in the human body, or (b) to support and/or maintain and sustain human life. If they fail, it is reasonable to assume that the health of the user may be endangered.



**Revision History:**

Previous Version:

Page	Subjects (major changes since last revision)	Date of change